



15F2930

# B737 (600-900 & Max) Towbar



Building Quality Ground Support Products Since 1961

- 8" x 15' high strength aluminum tube
- Fully retractable hydraulic running gear for adjustable height
- Safety lock system to avoid separation from aircraft
- Durable powder coat paint
- Quality shear bolts for aircraft protection
- Extra set of shear bolts included
- Solid tires
- Options:
  - Foam filled tires
  - Pneumatic tires
  - Cushioned lunette assembly
  - Spliced tube for easy transport

# CLYDE

Clyde Machines  
P.O. Box 194  
1150 Hwy 55 N.  
Glenwood, MN 56334 USA  
(320) 634-4504  
(320) 634-4506 Fax

[www.clydemachines.com](http://www.clydemachines.com)

# 15F2930

## B737 (600-900 & Max) Towbar

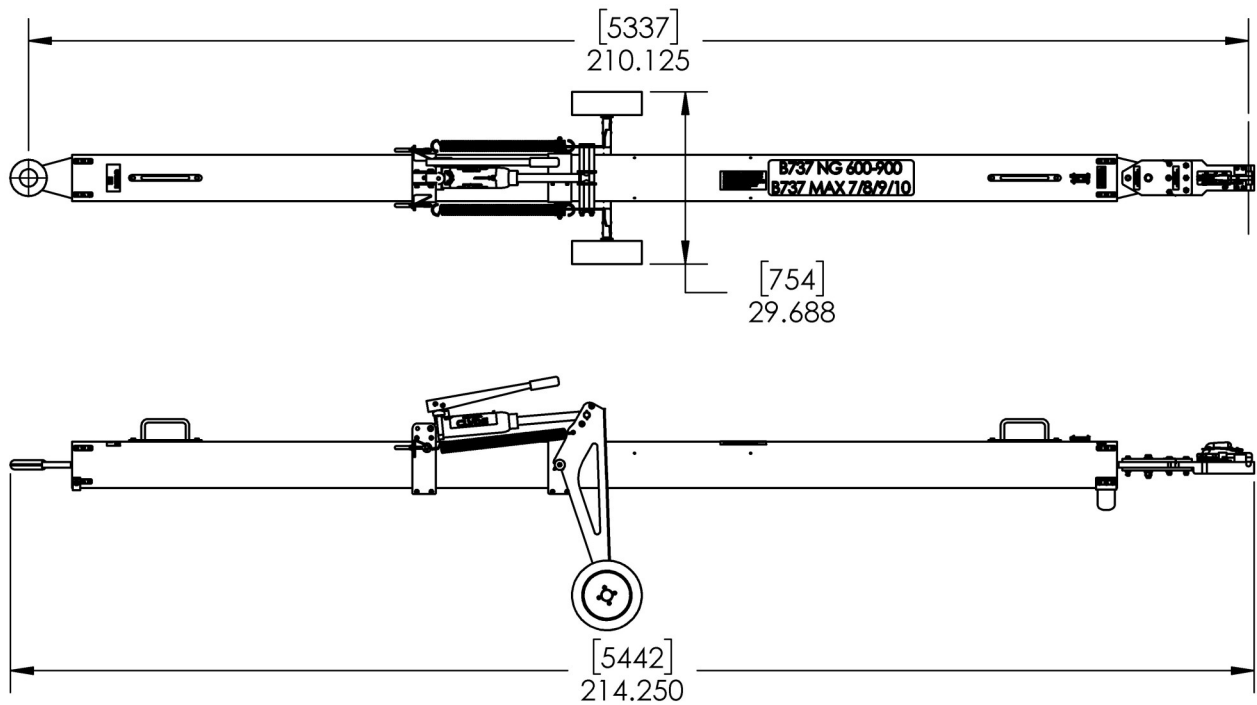

### Shipping Information

- Shipping Dimensions:
  - Weight — 350 lbs.
  - Length — 215"
  - Width — 30"
  - Height — 25"
- Crated Dimensions:
  - Weight — 770 lbs.
  - Length — 217"
  - Width — 26"
  - Height — 28"

# CLYDE

Clyde Machines  
P.O. Box 194  
1150 Hwy 55 N.  
Glenwood, MN 56334 USA  
(320) 634-4504  
(320) 634-4506 Fax

[www.clydemachines.com](http://www.clydemachines.com)