



15F2397

Wide Body Towbar



Building Quality Ground Support Products Since 1961

- 8" OD x 8' High strength steel tube
- Fully retractable hydraulic running gear for adjustable height
- Safety lock system to avoid separation from aircraft
- Durable powder coat paint
- Quality shear bolts for aircraft protection
- Extra set of shear bolts included
- Pneumatic tires
- Options:
 - Solid tires
 - Cushioned lunette assembly
- Model Fits:
 - DC10
 - B767
 - L1011
 - A340 200/300
 - MD11
 - A330
 - A350
 - B777*
 - B787*

CLYDE

Clyde Machines
P.O. Box 194
1150 Hwy 55 N.
Glenwood, MN 56334 USA
(320) 634-4504
(320) 634-4506 Fax

www.clydemachines.com

15F2397

Wide Body Towbar

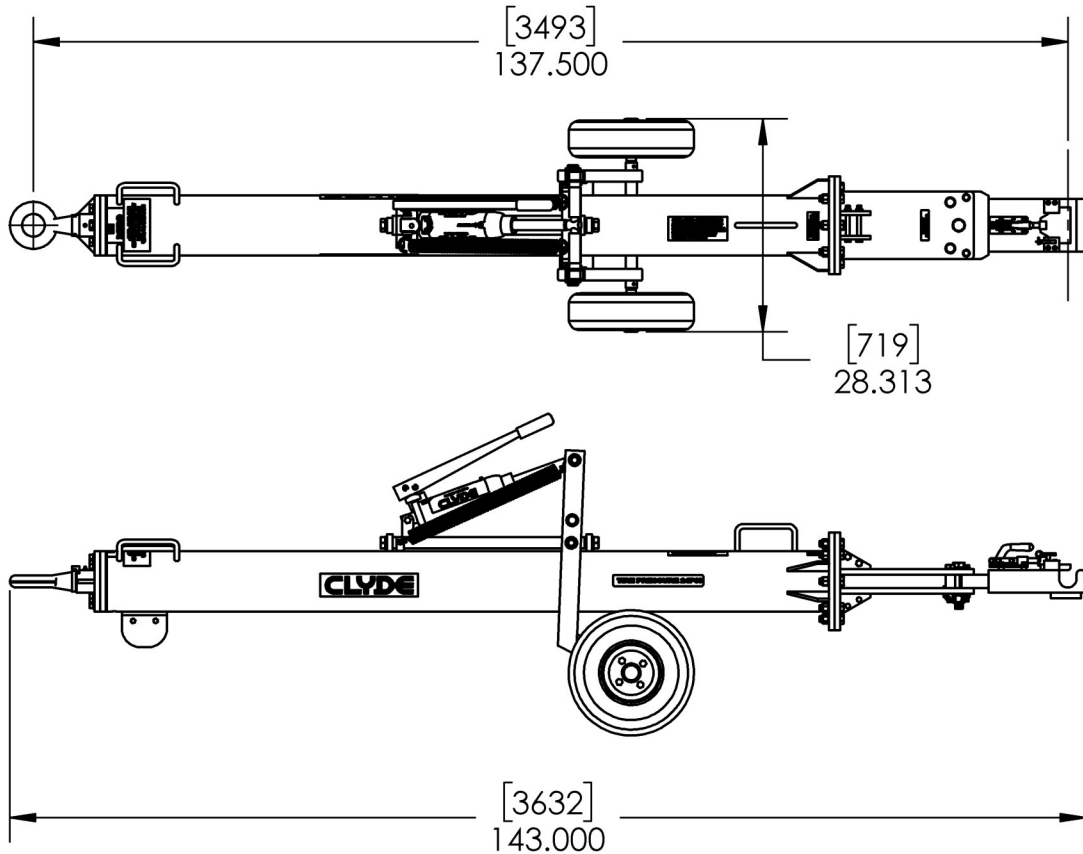

Shipping Information

- Shipping Dimensions:
 - Weight — 650 lbs.
 - Length — 143”
 - Width — 29”
 - Height — 25”
- Crated Dimensions:
 - Weight — 980 lbs.
 - Length — 152”
 - Width — 26”
 - Height — 36”

* “For use as dedicated B777/B787 towbar a shear pin, part #1504708, is offered. This heavier shear pin is not for use on other applicable aircraft models.”

** “Some pushback tractors may require a longer towbar to clear aircraft nose. Model 15F3045 is offered”

CLYDE

Clyde Machines
P.O. Box 194
1150 Hwy 55 N.
Glenwood, MN 56334 USA
(320) 634-4504
(320) 634-4506 Fax

www.clydemachines.com